



# BOLLARDS Street Furniture

**MODERN GARDENS FOR GARDENS EQUIPMENT TRADING LLC**

PO Box 128619 Abu Dhabi UAE | Tel +971 2 650 8039 | Fax +971 2 673 5995  
Email [moderngardens@gmail.com](mailto:moderngardens@gmail.com) | [marketing.moderngardens@gmail.com](mailto:marketing.moderngardens@gmail.com)

P.O Box No. 11169 Manama, Kingdom of Bahrain  
Mobile +973 66628877 | Email [bahrain.moderngardens@gmail.com](mailto:bahrain.moderngardens@gmail.com)

Website [moderngardensuae.com](http://moderngardensuae.com)





## | CONCRETE BOLLARDS

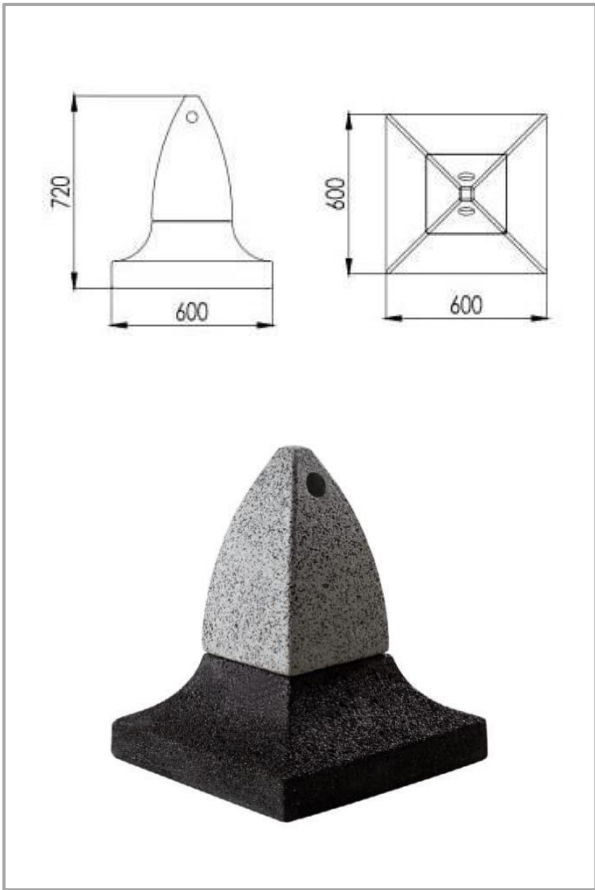

### DOGAL BOLLARD

DIMENSIONS | 600 X 600 X 470mm

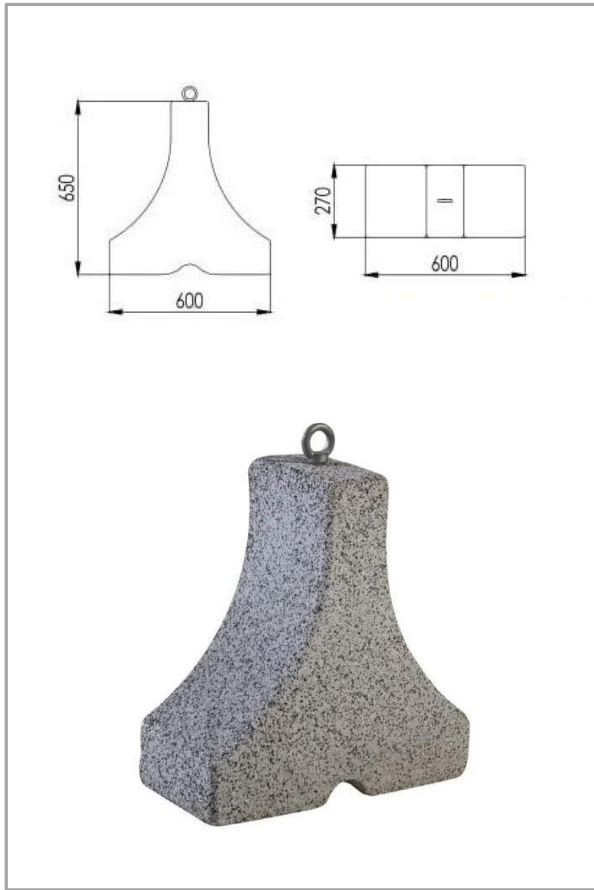

### DAVET BOLLARD

DIMENSIONS | 270 X 800 X 650mm

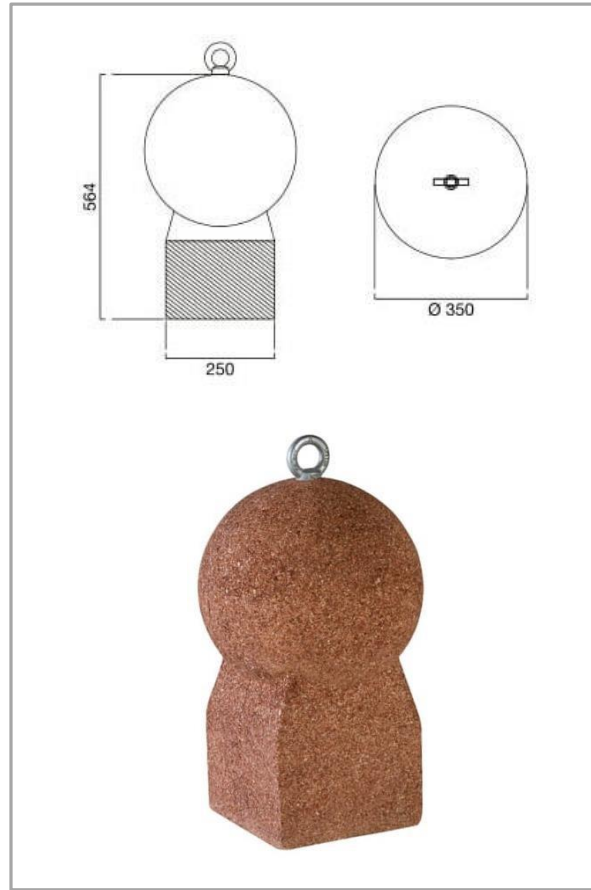

### KURE BOLLARD

DIMENSIONS | 400 X 400 X 400mm

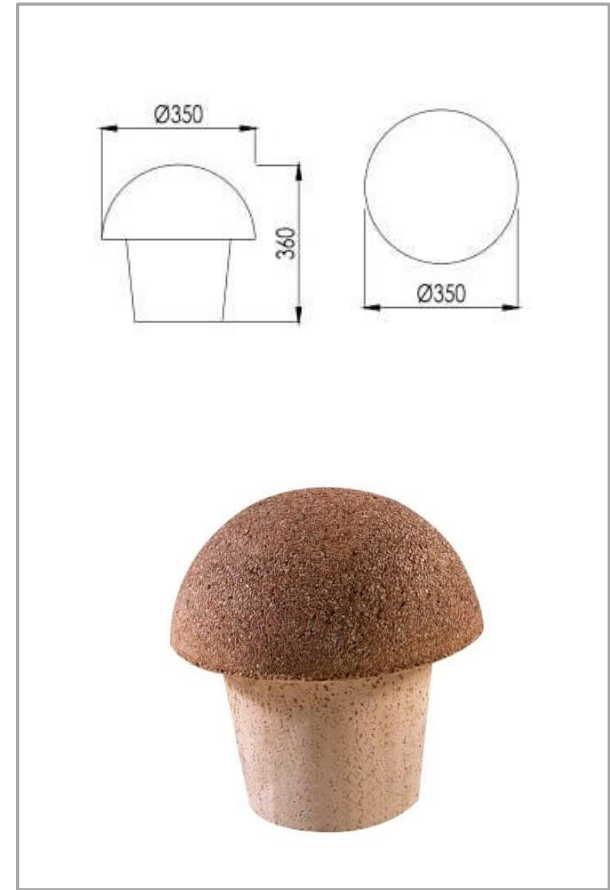

### MANTAR BOLLARD

DIMENSIONS | 270 X 800 X 650mm



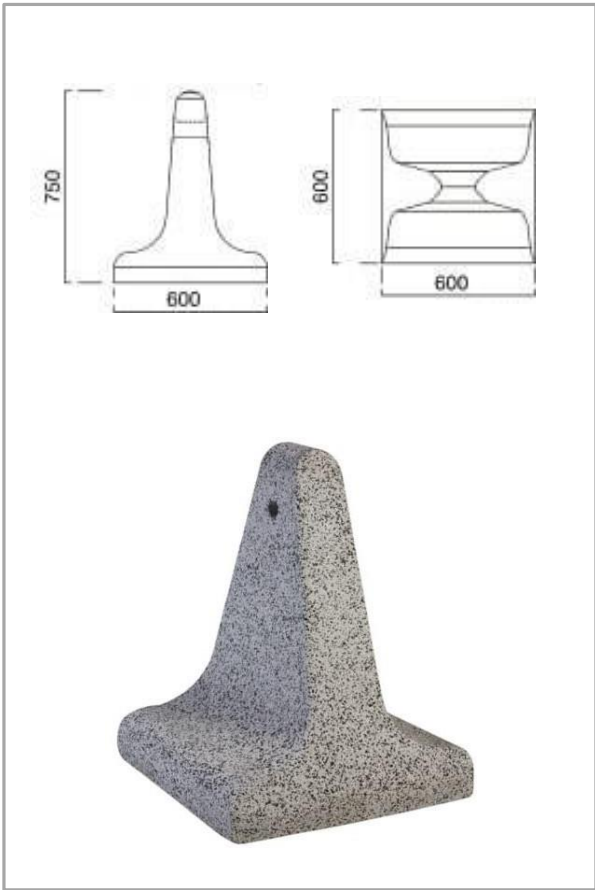

### DINAMIK BOLLARD

DIMENSIONS | 400 X 400 X 400mm

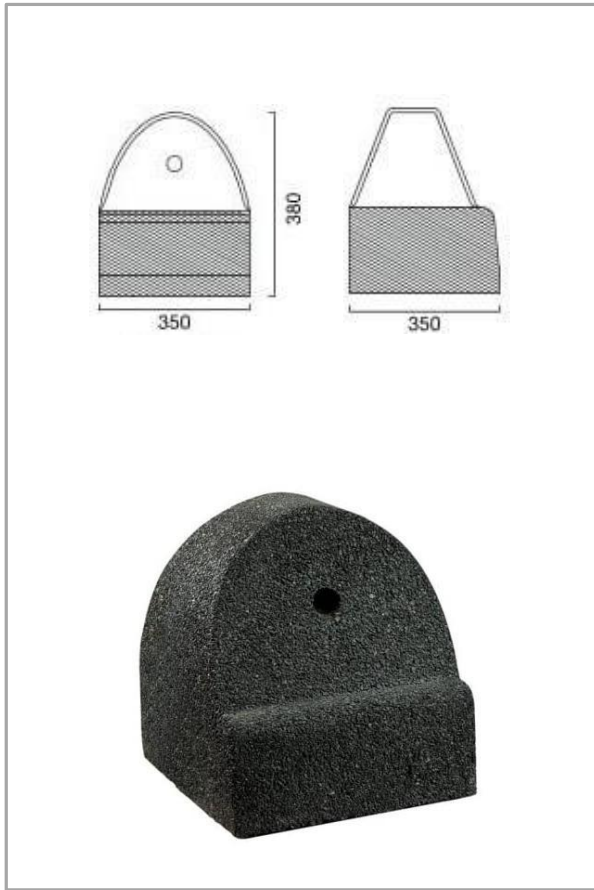

### L BORDURE

DIMENSIONS | 270 X 800 X 650mm

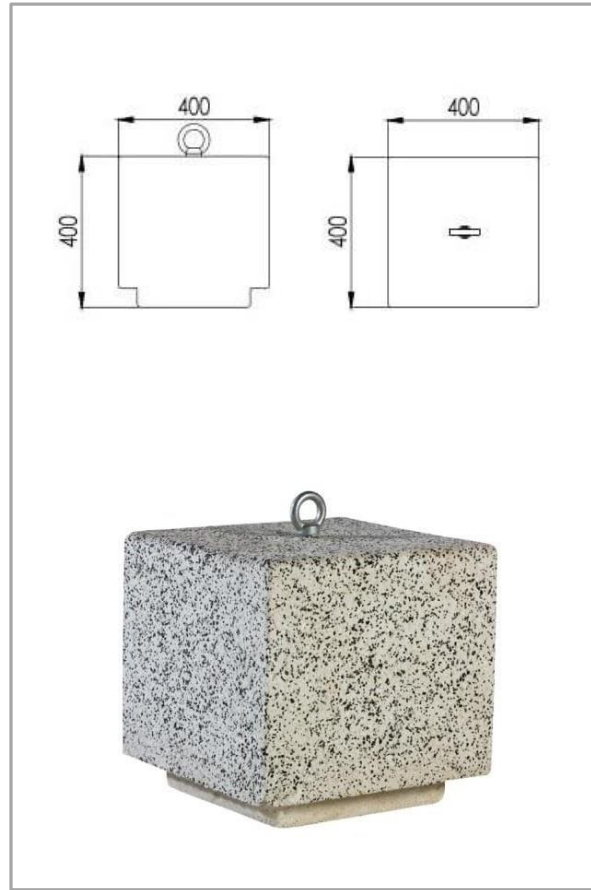

### DEKO SMALL BOLLARD

DIMENSIONS | 400 X 400 X 400mm



### DEKO BOLLARD

DIMENSIONS | 400 X 400 X 800mm



### SELCUK BOLLARD

DIMENSIONS | 270 X 800 X 650mm

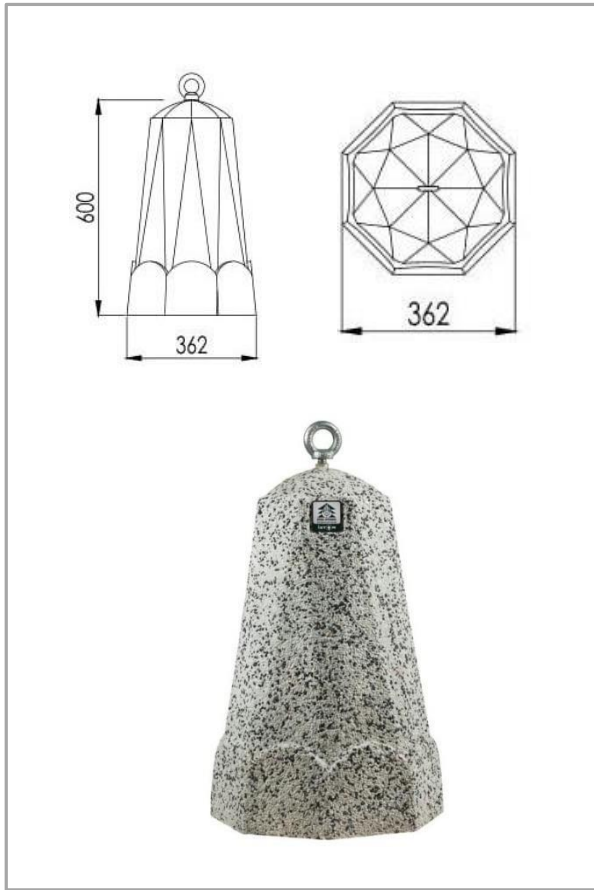

### BAGDAT BOLLARD

DIMENSIONS | 400 X 400 X 400mm

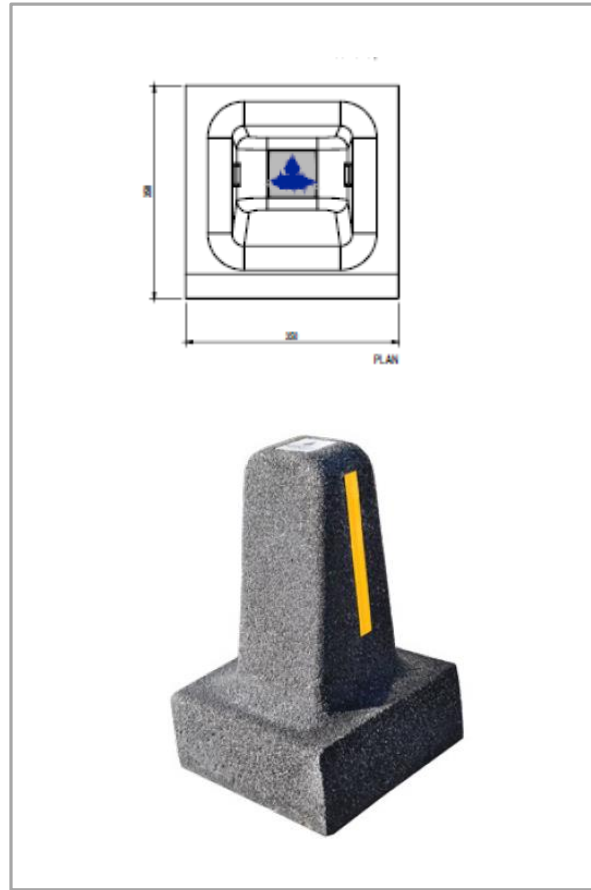

### PRESTIGE BOLLARD WITH BASE

DIMENSIONS | 350 X 300 X 580mm

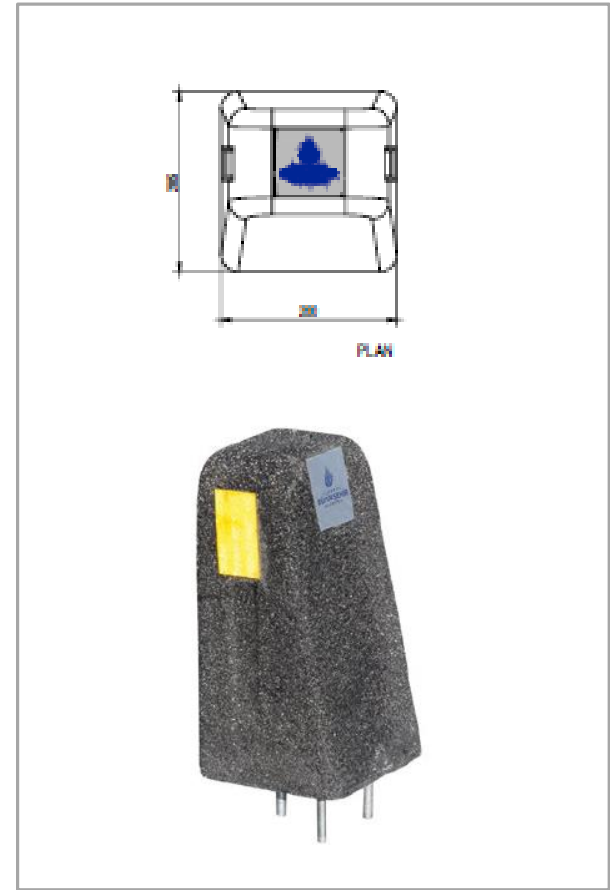

### PRESTIGE BOLLARD

DIMENSIONS | 205 X 200 X 430mm





CONCRETE BOLLARDS |







# | METAL BOLLARDS



### METALIC BOLLARD

DIMENSIONS | 168 X 168 X 500mm



### TECHNICAL DETAILS

DIMENSIONS | 248 X 215 X 819



### STEEL BOLLARD (HOT GALVANIZED)

DIMENSIONS | 150 X 300 X 400mm



### CAST ALUMINUM BOLLARD

DIMENSIONS | 150 X 150 X 780mm





**YLLZ-F**

**MATERIAL | STAINLESS STEEL**

**MOUNTING | BOLT DOWN, FIXED BASE PLATE, AND WITH DECORATION COVER**



**YLLZ-D**

**MATERIAL | STAINLESS STEEL**

**MOUNTING | BOLT DOWN, FIXED BASE PLATE, AND WITH DECORATION COVER**



**YLLZ-M**

**MATERIAL | STAINLESS STEEL**

**MOUNTING | BOLT DOWN, FIXED BASE PLATE, AND WITH DECORATION COVER**



**YLLZ-W**

**MATERIAL | STAINLESS STEEL**

**MOUNTING | BOLT DOWN, FIXED BASE PLATE, AND WITH DECORATION COVER**



**ATB-7110 Series**

MATERIAL | S275JR STEEL

MOUNTING | HYDRAULIC DRIVEN



**ATB-6590**

MATERIAL | S275JR STEEL

MOUNTING | HYDRAULIC DRIVEN



**HB Series**

MATERIAL | S275JR STEEL

MOUNTING | HYDRAULIC DRIVEN



**FB Series**

MATERIAL | S275J2 OR 304 STAINLESS STEEL

MOUNTING | FIXED BASE PLATE





## YLLZ-F

MATERIAL | S275J2R OR 304 STAINLESS (326 STAINLESS AS AN OPTION)

MOUNTING | FIXED BASE PLATE



## SUB Series

MATERIAL | S275J2R

MOUNTING | HYDRALUIC DRIVEN

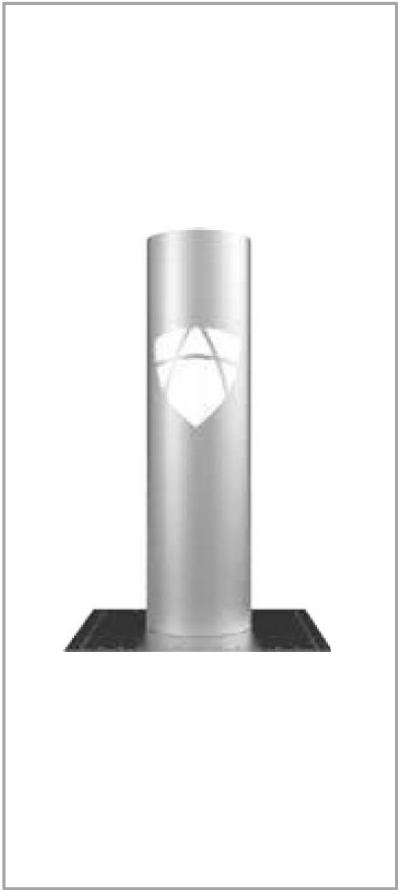

**ATB-7110 Series**

MATERIAL | STAINLESS STEEL

MOUNTING | BOLT DOWN, FIXED BASE PLATE, AND WITH DECORATION COVER



**ATB-6590**

MATERIAL | STAINLESS STEEL

MOUNTING | BOLT DOWN, FIXED BASE PLATE, AND WITH DECORATION COVER



**HB Series**

MATERIAL | STAINLESS STEEL

MOUNTING | BOLT DOWN, FIXED BASE PLATE, AND WITH DECORATION COVER



**FB Series**

MATERIAL | STAINLESS STEEL

MOUNTING | BOLT DOWN, FIXED BASE PLATE, AND WITH DECORATION COVER



**MB Series**

MATERIAL | STAINLESS STEEL

MOUNTING | BOLT DOWN, FIXED BASE PLATE, AND WITH DECORATION COVER





### STAINLESS STEEL BOLLARD

MOUNTING | BOLT DOWN, IN GROUND, AND REMOVABLE



### LONDON BOLLARD

MATERIAL | CAST ALUMINUM , COLOUR CUSTOMIZABLE



### DOME TOP BOLLARD

MATERIAL | MILD STEEL PIPE COLUMN, WELL FINISHED POWDER COATING



### B11 BOLLARD

MATERIAL | STURDY MILD STEEL WITH A UNIQUE CAP DESIGN



### **BARRIER BOLLARD**

**MATERIAL | STURDY MILD STEEL WITH A HIGH-VISIBILITY BAND**

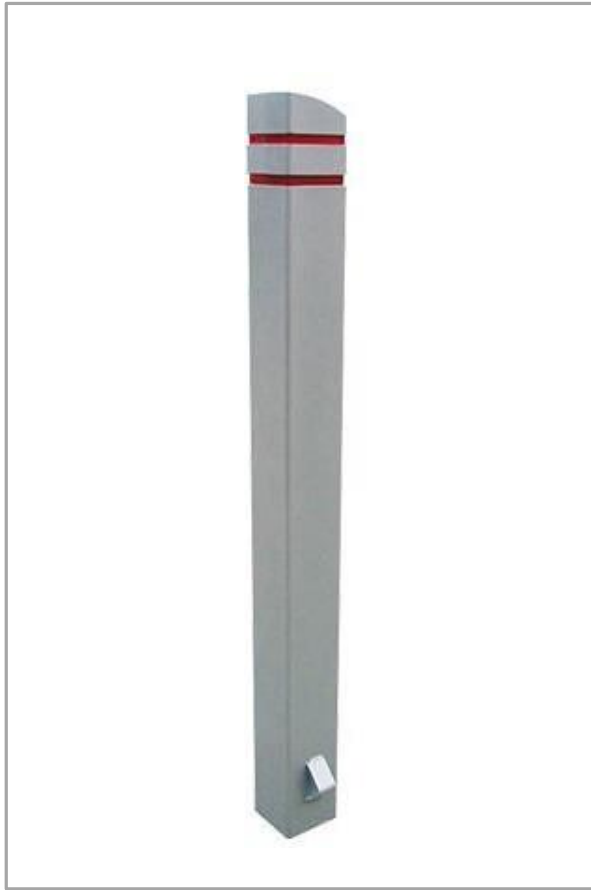

### **TRAVERSE BOLLARD**

**MATERIAL | HOT DIPPED GALVANISED MILD STEEL, POWDER COATED**



### **OLDE SYDNEY BOLLARD**

**MATERIAL | CAST ALUMINUM, POWDER COATED IN CUSTOM COLOR**



### **EDGE WATER BOLLARD**

**MATERIAL | SMOOTH CURVED CAST-ALUMINUM, POWDER COATED**



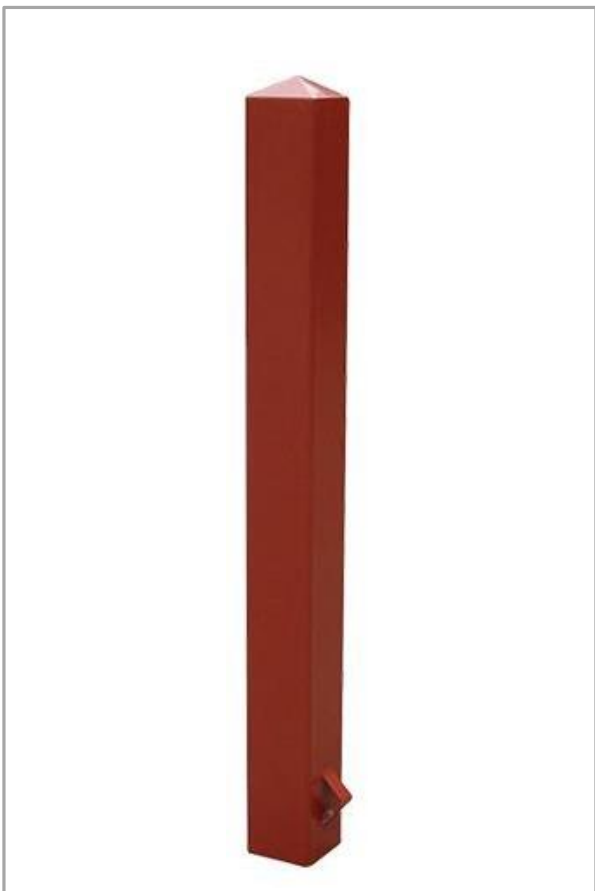

**OLDE SYDNEY BOLLARD**

MATERIAL | HOT-DIPPED GALVANIZED PIPING,  
POWDER COATER IN CUSTOM COLOR



**CORSO BOLLARD**

MATERIAL | CAST ALUMINUM, UNIQUE DESIGN



**NOTA BOLLARD**

MATERIAL | 180° BENDING BAR, GALVANIZED AND  
POWDER COATED



**BRASILIA BOLLARD**

MATERIAL | GALVANISED STEEL, POWDER COATED, IN  
DIFF. RAL COLORS



### VIENNA BOLLARD

MATERIAL | GREY CAST IRON, SEALED BY ZINC PHOSPHATE PRIMING, FORGED EFFECT ANTICORROSION FINISH



### BERGAMO BOLLARD

MATERIAL | TUBULAR STEEL, GALVANIZED AND POWDER COATED

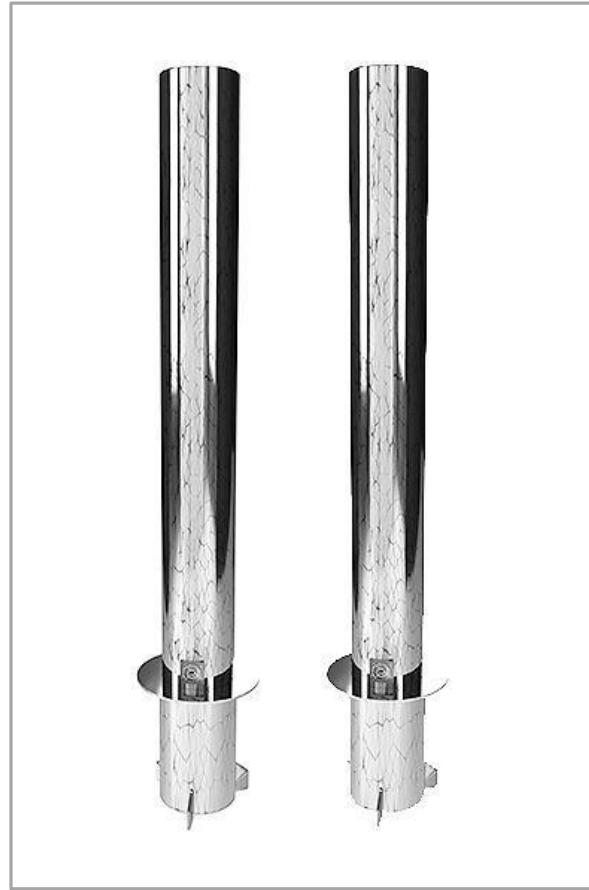

### REMOVABLE BOLLARD

MATERIAL | 125NB CHS stainless steel and sleeve No additional lock required to secure the cap When the bollard is in or out - No hinges, springs, therefore far less likely to break - Lock/key only 50mm above the ground - less moving parts - Bollard removed With just an unlock/easy twist.



### Flexible Traffic Bollard With reflector



### **JEKO BOLLARD**

DIMENSIONS | 70 X 50 X 1000mm

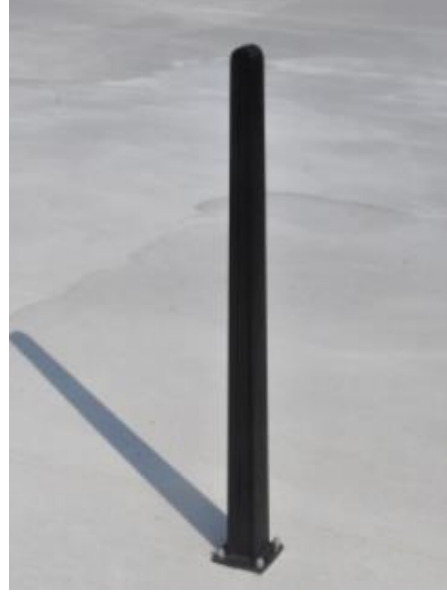

### **ALUSO BOLLARD**

DIMENSIONS | 120 X 120 X 1140mm



### **SIMPLE BOLLARD**

DIMENSIONS | 76mm



### **KATAO BOLLARD**

DIMENSIONS | 140 X 800mm



## PHAD BOLLARD

A  $\varnothing$  101.6mm bollard made of tubular, AISI 304 stainless steel With an original moulded tip and a  $\varnothing$ 180 mm circular base plate. In addition to the standard fixed version, a removable version is available.

Technical specifications

Height above ground level: 102 cm

Depth: 10 cm Length: 10 cm Weight: 6 kg



## HOSPOTALET BOLLARD

A cylindrical, S235JR steel bollard With an AISI 304 stainless steel decorative ring.

Technical specifications

Height above ground level: 80 cm

Depth: 10 cm Length: 10 cm Weight: 5 kg







## PLAZA BOLLARD

A cylindrical bollard that livens up streets and squares, making its mark thanks to its elegant, AISI 304 stainless steel top combined with a  $\varnothing$  130mm. Cor-ten steel tube.

Technical specifications

Height above ground level: 80 cm

Depth: 13 cm Length: 13 cm Weight: 8 kg



## SIRIO BOLLARD

A bollard made of AISI 304 stainless steel sheet or Cor-ten steel. The laser-cut sheet steel creates the illusion that the bollard is rotating: seen from different angles, it appears to change shape. An optional LED signal in the base is available.

Technical specifications

Height above ground level: 90 cm

Depth: 23 cm Length: 26 cm Weight: 15 kg







## ANCHISE BARRIER

A barrier made of Ø 60mm., AISI 304 curved stainless steel tube. Covered With a stainless steel sheet. This can be personalized With logos or patterns cut using a Water jet.

Technical specifications

Height above ground level: 90 cm

Depth: 6 cm Length: 90 cm Weight: 18 kg



## LIMES BARRIER

A modern reWorking of the classic-style barrier made of S235JR steel. The basic unit of this modular system consists of two, square-section columns, topped With ornamental spheres. The central panel is made of intersecting tubes With circular plaques at the centre on both sides.

Technical specifications

Height above ground level: 104 cm

Depth: 4 cm Length: 208 cm Weight: 22 kg





## MIRRA BARRIER

The external frame of this S235JR steel barrier is made of vertical and horizontal angular section profiles. The internal design consists of two strips: one set diagonally and the other v-shaped. There are two horizontal rods at the bottom.

Technical specifications

Height above ground level: 100 cm

Depth: 8 cm Length: 200 cm Weight: 35 kg



## ISOLA ECOLOGICA

A modular system designed to demarcate and conceal urban, recycling areas. The system consists of a series of perforated panels in S235JR steel sheet. The structure is supported by lateral tubes.

Technical specifications

Height above ground level: 170 cm

Depth: 10 cm Length: 112 cm Weight: 30 kg





# | SECURITY BOLLARDS



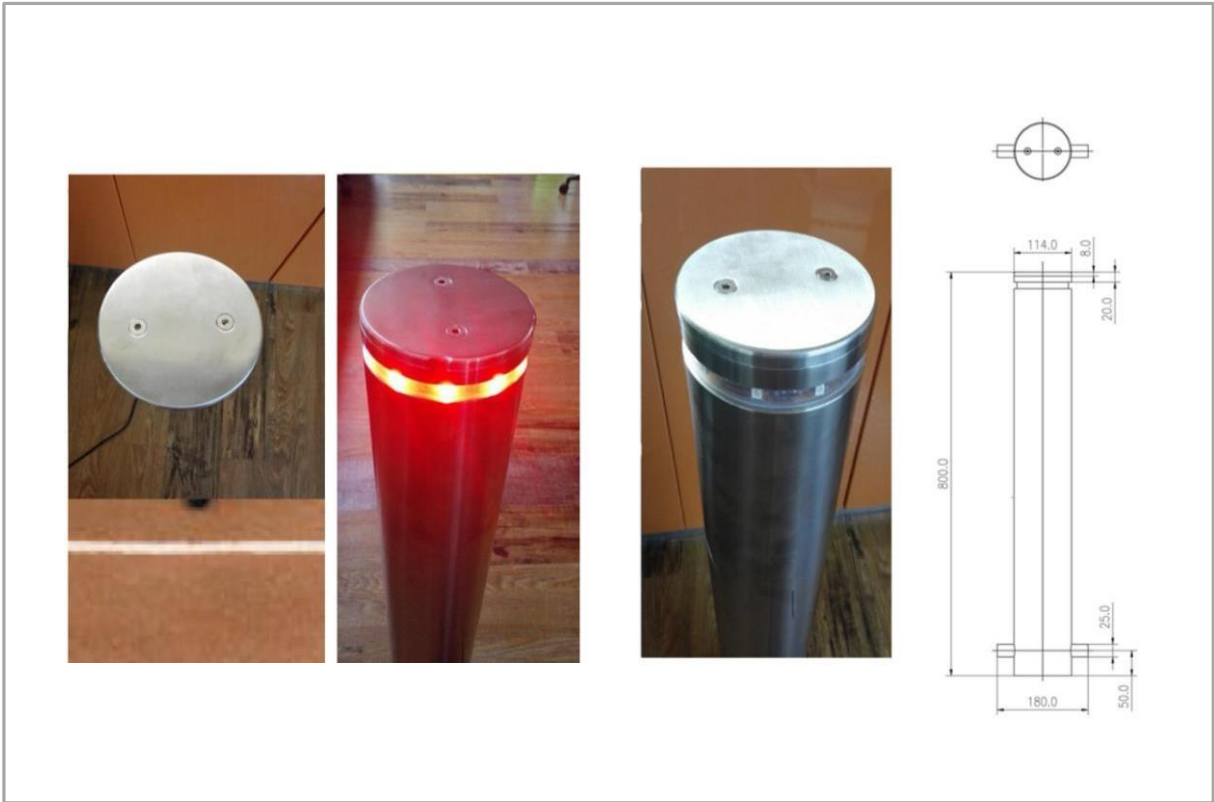

### FIXED BOLLARD WITH LIGHT

- FEATURES | A. ECONOMICAL AND EASY TO INSTALL
- B. MATCH TO OTHER BOLLARDS SIZE AND STYLE
- C. HEIGHT ABOVE GROUND: 800mm (OPTIONAL)
- D. OPTIONAL REFLECTIVE TAPE



## Hydraulic bollard

Hydraulic automatic bollard mainly consists of oil pump unit and steel frame construction. It uses oil pressure as a dynamic to realize the rise/fall of bollard. As a moving device, it is usually installed at vehicle entrance/exit. It rises to block the vehicle and falls the ground level to authorize free passing.



## HYDRAULIC BOLLARD

- FEATURES | A. HYDRAULIC MOVEMENT  
B. BUILT-IN HYDRAULIC PUMP IN THE BOLLARD  
C. PATENTED SYSTEM FOR THE PROTECTION OF HANDLING





### Pneumatic bollard

Automatic pneumatic bollards, controlled by electricity, rise/fall automatically. It uses air as power and it is a environment-friendly product. It can achieve unified control, and assembled power, and it is easy to operate. For short, it is a high-security product with high-speed and high-impact performance.

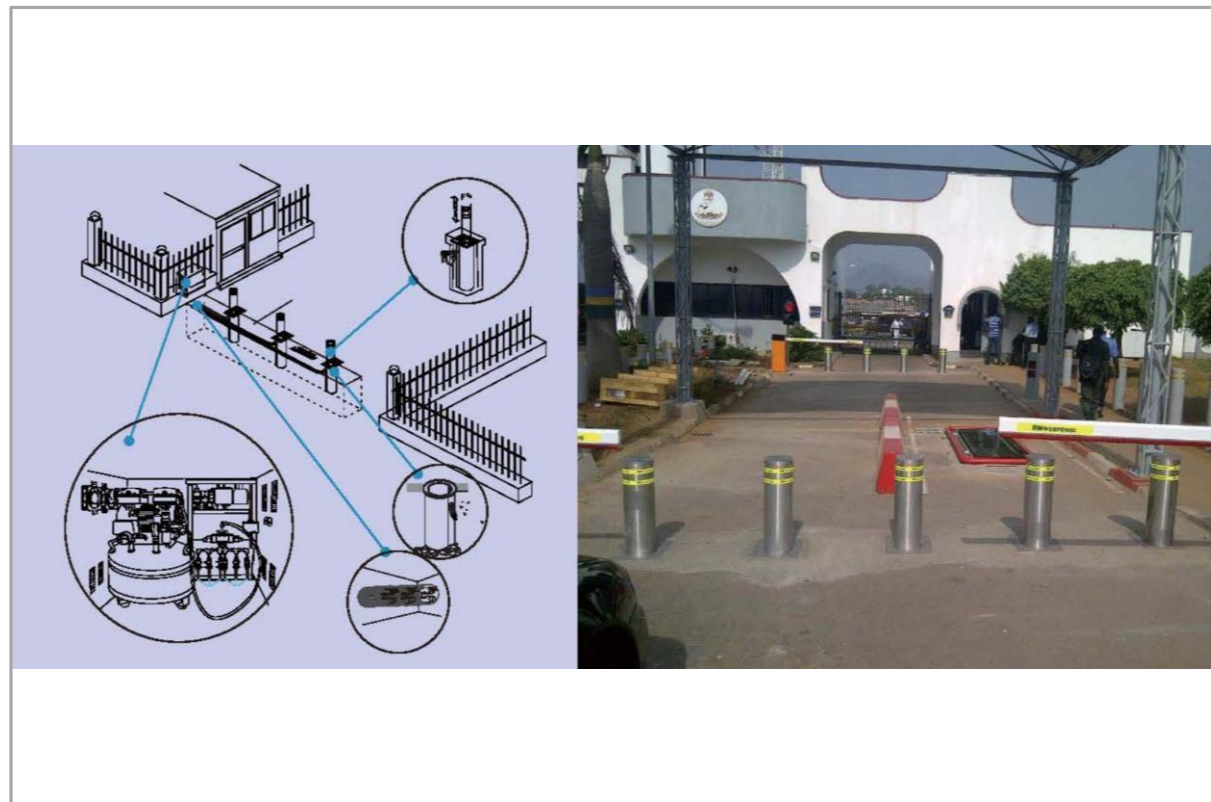

## PNEUMATIC BOLLARD

- FEATURES |
- A. HIGH SECURITY AND ANTI-COLLISION ABILITY
  - B. PNEUMATIC AIR PUMP IN CONTROL CABINET COULD PROVIDE LARGE POWER SAFELY
  - C. ELECTRONIC CONTROL, AUTOMATIC RISE/FALL
  - D. HIGH SYSTEM INDEPENDENCE



### Semi-auto bollard

The semi-automatic bollard has been designed to control access to a site with a high level security, guaranteeing pedestrian access whilst blocking the area to road traffic.

### OPERATION FLOW CHART

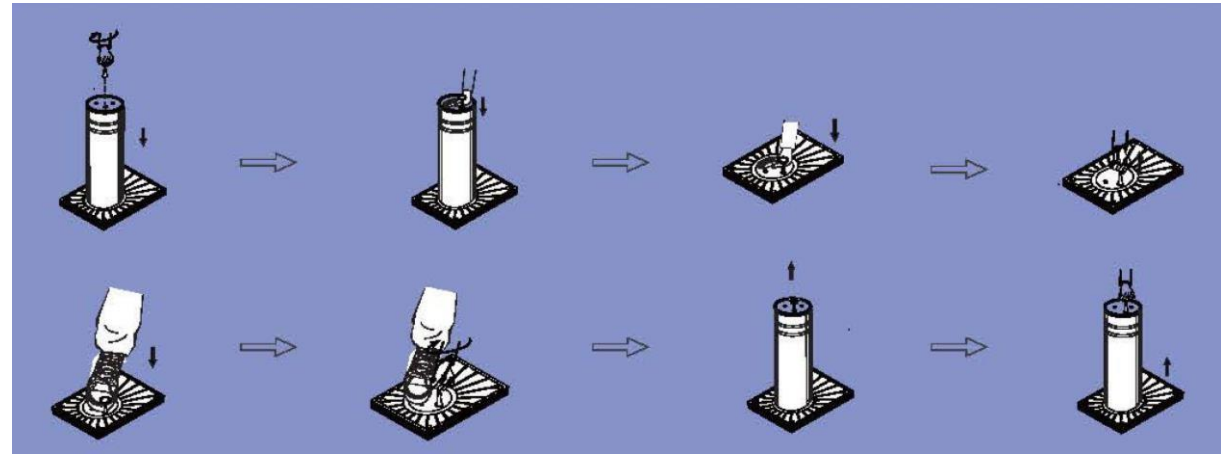

### SEMI-AUTO BOLLARD

- FEATURES | A. BOLLARD IS RAISED BY A GAS SPRING  
 B. HIGH IMPACT STRENGTH, NO POWER SUPPLY NEEDED  
 C. HEIGHT ABOVE GROUND: 600MM / 750MM / 900MM  
 D. DIFFERENT COLOR REFLECT TAPE (OPTIONAL)



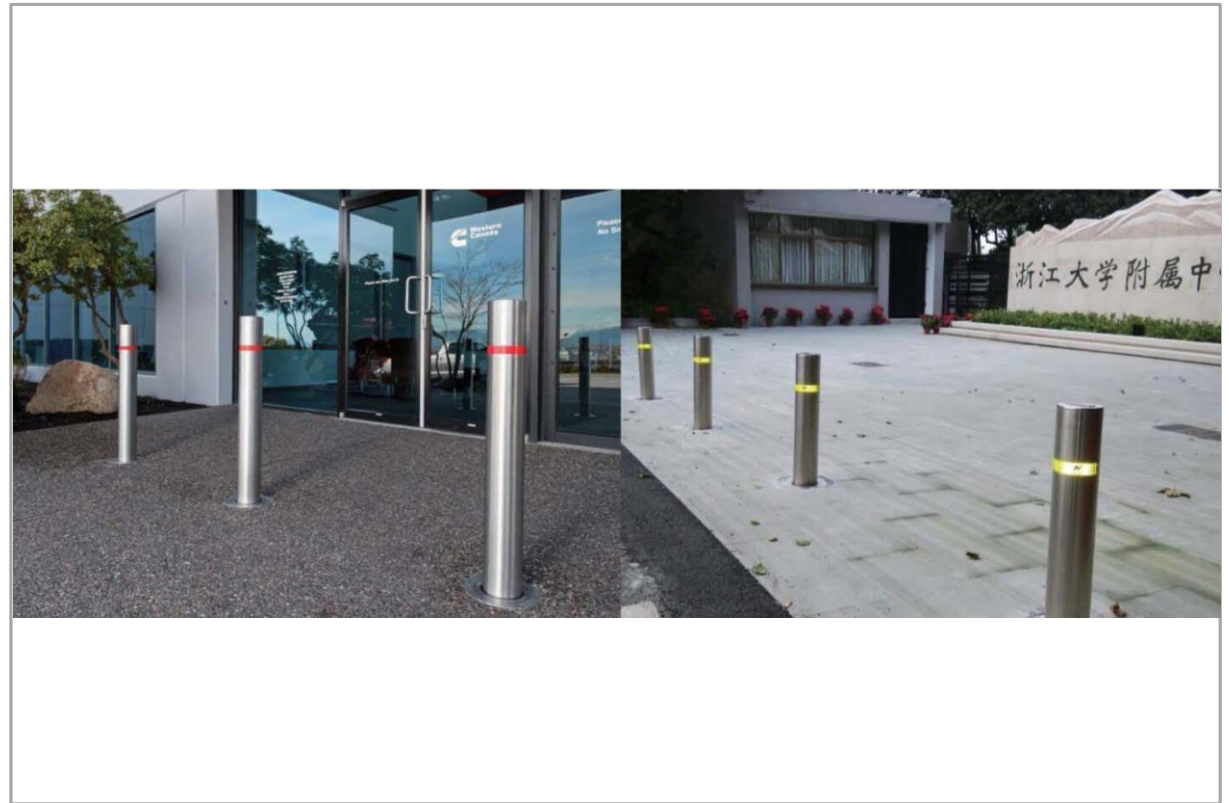

## FOLDING BOLLARD

- FEATURES | A. BOLLARD CAN BE LOCKED ON THE FLOOR FOR ENHANCE SECURITY  
 B. OFFERS ATTRACTIVE AESTHETICS  
 C. THICK WALL BODY OF 3MM



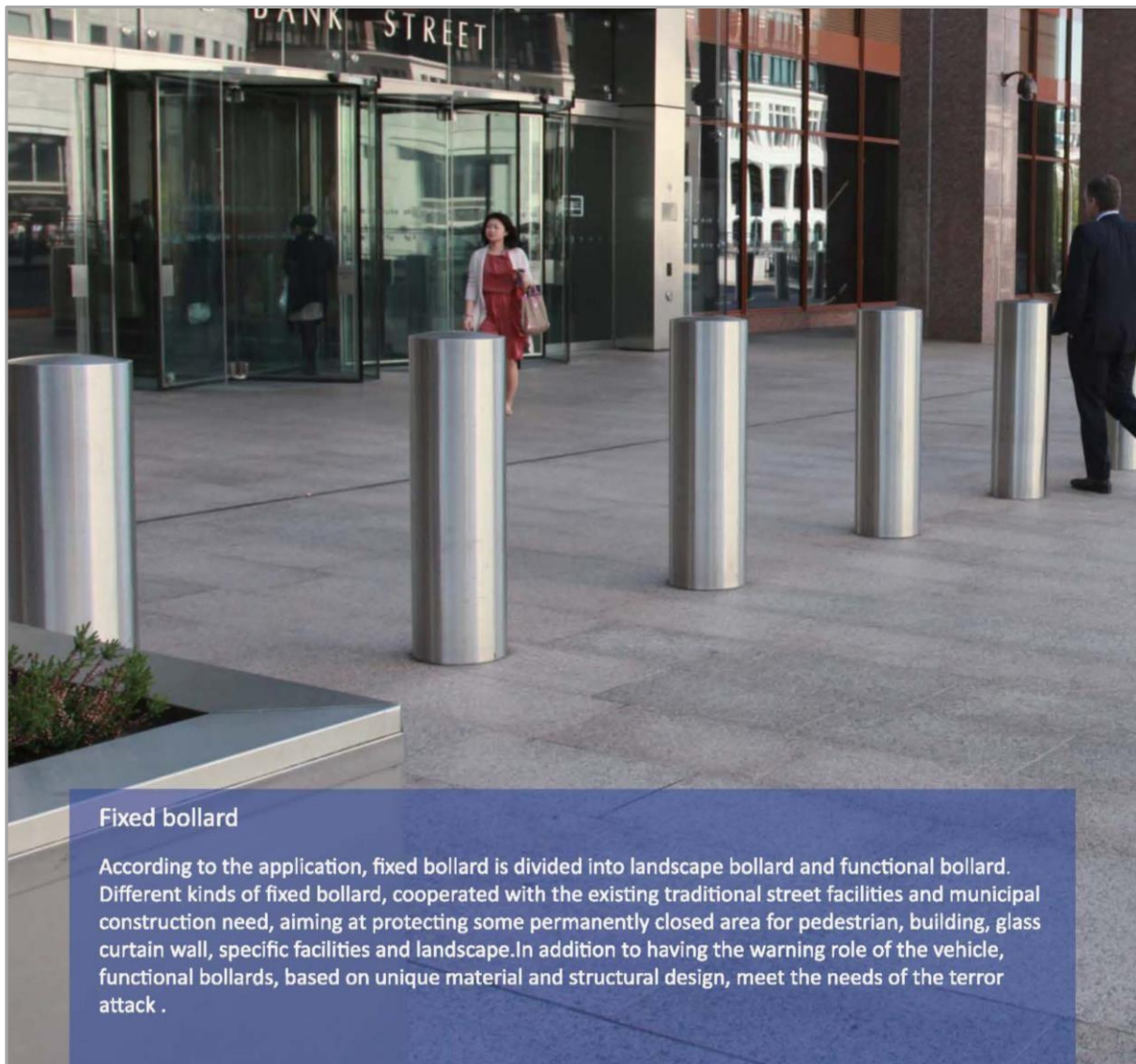

### Fixed bollard

According to the application, fixed bollard is divided into landscape bollard and functional bollard. Different kinds of fixed bollard, cooperated with the existing traditional street facilities and municipal construction need, aiming at protecting some permanently closed area for pedestrian, building, glass curtain wall, specific facilities and landscape. In addition to having the warning role of the vehicle, functional bollards, based on unique material and structural design, meet the needs of the terror attack .

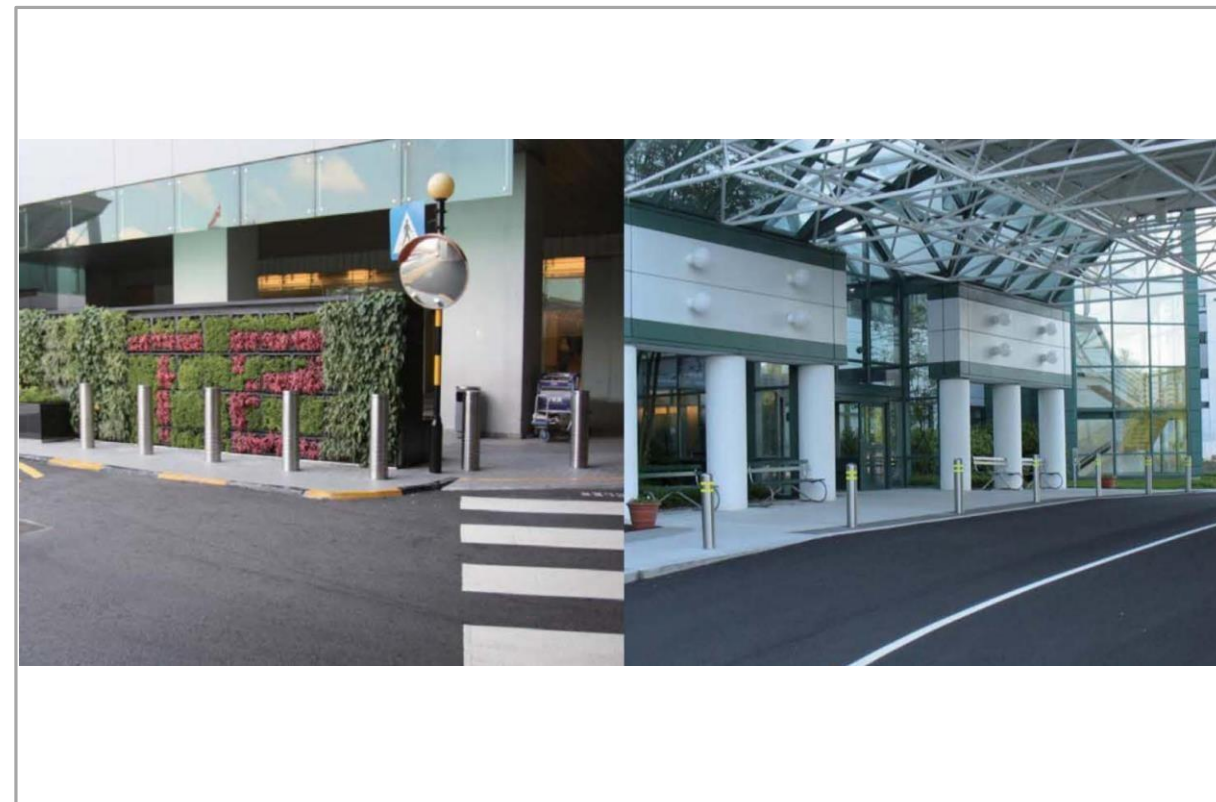

### FIXED BOLLARD

FEATURES | A. DIFFERENT SIZES, MATERIALS, THICKNESS  
B. CAN BE CUSTOMISED IN DIFFERENT RAL COLOURS  
C. COULD BE APPLIED TO HIGH-SECURITY ANTI-TERROR REQUIREMENTS



# BOLLARDS Street Furniture

**MODERN GARDENS FOR GARDENS EQUIPMENT TRADING LLC**

PO Box 128619 Abu Dhabi UAE | Tel +971 2 650 8039 | Fax +971 2 673 5995  
Email [moderngardens@gmail.com](mailto:moderngardens@gmail.com) | [marketing.moderngardens@gmail.com](mailto:marketing.moderngardens@gmail.com)

P.O Box No. 11169 Manama, Kingdom of Bahrain  
Mobile +973 66628877 | Email [bahrain.moderngardens@gmail.com](mailto:bahrain.moderngardens@gmail.com)

Website [moderngardensuae.com](http://moderngardensuae.com)